

Installations manual

PC1000 / PC1400 / PC2000

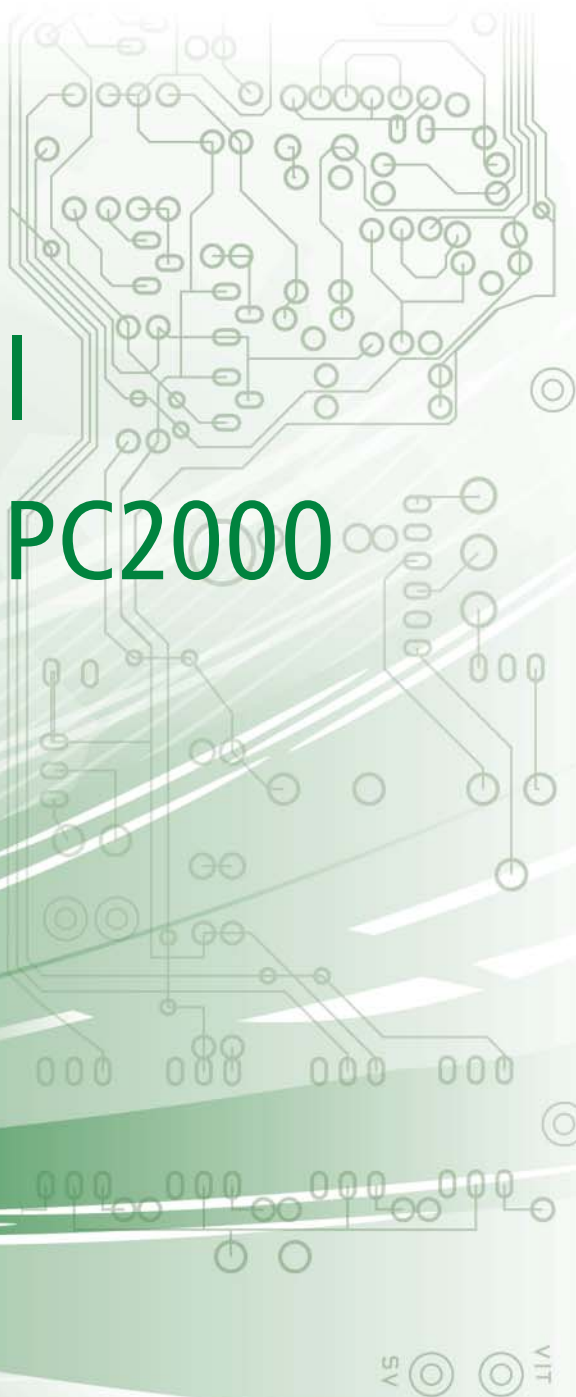

POLYAMP 



PC2000-series 1000 to 2000 W

INPUT / OUTPUT

- Optimized input voltage ranges
- Input ranges from 20 to 300 Vd.c.
- Single outputs from 24 to 48 Vd.c.
- Inrush current limit
- Reverse input voltage protection

OPERATION

- Operating temperature range -25 to +55 °C
- High efficiency > 89%
- Convection cooled 1000 W
- Fan cooled up to 1400 to 2000 W

INPUT			
Nominal inputs	Input range	Stop level	Code
24 Vd.c.	20-32 V	<16.8 Vd.c.	24
48 Vd.c.	43-60 V	<33.6 Vd.c.	48
110, 127 Vd.c.	93-150 V	<77 Vd.c.	110
220, 250 Vd.c.	187-300 V	<154 Vd.c.	220

Other input ranges can be made on demand.

Input range, is the range we guarantee full output performance, $U_{out} +10\%$, $I_{out} +5\%$.

The converter works down to the stop levels.

The output voltage might decrease to approx -10% of nominal output at the stop level.

FEATURES

- Current sharing
- External output voltage sense
- Overvoltage protection OVP
- Alarm circuit with relay
- Inhibit input / Power down
- Output voltage adjustable on frontpanel

EMC

- EN IEC 61000-6-3, Emission.
- EN IEC 61000-6-2, Immunity.
- EN IEC 61000-4-3, 20 V/m
- EN IEC 61000-4-4, 4 kV.
- EN IEC 61000-4-5 level 2 & 3.
- EN 50121-3-2

OUTPUT		
Voltage	Current	Power
24 V	42-58 A	1000-1400 W
28 V	36-50 A	1000-1400 W
48 V	21-42 A	1000-2000 W

OUTPUT RATING & TYPE CODE

OUTPUT			INPUT				
Voltage	Current	Power	20 - 32 V	43 - 60 V	93 - 150 V	187 - 300 V	Cooling
24 V	42 A	1000 W	PC1000 24/24	PC1000 48/24	PC1000 110/24	PC1000 220/24	Convection
24 V	58 A	1400 W		PC1400 48/24	PC1400 110/24	PC1400 220/24	Fan
28 V	36 A	1000 W	PC1000 24/28	PC1000 48/28	PC1000 110/28	PC1000 220/28	Convection
28 V	50 A	1400 W		PC1400 48/28	PC1400 110/28	PC1400 220/28	Fan
48 V	21 A	1000 W	PC1000 24/48	PC1000 48/48	PC1000 110/48	PC1000 220/48	Convection
48 V	42 A	2000 W		PC2000 48/48	PC2000 110/48	PC2000 220/48	Fan

* NRE might be changed

How to read our product code:

Example PC1000 110/48

PC1000 = Family code

110 = Input voltage code 110

48 = Output voltage 48 V

FEATURES

Current Sharing

Current sharing is used to balance the load between up to 10 units working in parallel.

External output voltage sense

External sense is used when the voltage regulation at the load is critical. See output data page 3. The sense can compensate voltage drops up to 5% of the nominal voltage.

Alarm circuit

The alarm relay switches to "ALARM" state if:

* The output voltage is not within -10 to +15% of nominal output voltage.

* The converter is overheated

Over voltage protection OVP

A second regulation circuit takes over in case the main regulation fails. The output voltage is limited to approximately +15% over nominal output voltage.

Inhibit input / Power down

The converter will shutdown if the inhibit input is short-circuit by a relay or electrical switch. The current through the short-circuit is 20mA. Note that there is no electrical isolation between the inhibit and the output.

Inrush current limit and Reverse voltage protection

All models have an inrush current limit circuit. In case the input is connected in reverse voltage the converter will not start. The reverse voltage do not damage the input of the converter.

Electrical Safety Installation Class

The PC2000 series can be installed in different networks, see page 4

OPTIONAL FEATURES

Series diode on output

Specify series diode output when the output is connected in parallel with other power supplies to achieve redundancy. The output is derated 10% on 24V and 5% on 48V.

Conformally coating

For use in weather protected area with high ambient humidity or large temperature gradients producing condensation.

Train input

Input voltage range according to train standard EN50155 and IEC60571. See T-input below.

T-INPUT RANGES FOR MOBILE APPLICATIONS

CODE	CONTINUOUS RANGE	UIN 0.1S-S2
24T	16.8 - 30Vd.c.	14.4 - 33.6 Vd.c.
48T	33.6 - 60 Vd.c.	28.8 - 67.2 Vd.c.
72T	50.4 - 90 Vd.c.	43.2 - 100.8 Vd.c.
110T	77 - 137.5 Vd.c.	66 - 154 Vd.c.

GENERAL DATA / INPUT DATA

LABEL	VALUE
Design topology	Push-Pull
Switching frequency	60 kHz
Emission / Immunity	See page 4
Safety EN IEC 60950-1:2001	See page 4
Max. accepted input ripple ¹ 50-400 Hz	2 % of nominal voltage
Input power at no load	
Input code 24	<8 W
Input code 48, 110	<17 W
Input code 220	<21 W
Reverse input voltage protection	In start up sequence ²
Inrush current limit	Yes <10 x Inom
Dimensions (D x W x H)	285 x 420 x 87 mm
Weight	8.5 kg
Power connectors	1 - 35 mm ²
Signal connectors	0,25 - 2,5 mm ²

1. Higher ripple affects the input, contact factory.
2. The converter do not start at reverse voltage.

3. The output ripple might increase to 0.5% RMS of Vout, when EN IEC 61000-4-3, 20 V/m test is applied.
4. Lowest efficiency measured within the whole input voltage range at 100% load.
5. Contact factory for derating as depends on model. The alarm relay can not be used at +70 °C

OUTPUT DATA

LABEL	VALUE
Source regulation	0.1%
Load regulation (0 to 100% load) with sense connected	0.2%
Load regulation (0-100% load)	0.5%
Transient recovery time for 10 to 90% load step to within 3% of nominal output voltage.	<3 ms
Output ripple (120 kHz) Vp-p ³	Typ. 30 mV
Input ripple attenuation to output (50 to 400 Hz)	150:1
Emission / Immunity	See page 4
Temperature coefficient	0.02%/°C
Min output adjustment range adjustable with a 15 turn potentiometer	95 - 110%
Current limit, rectangular	105%
Remote sense	Yes
Soft start	Yes
Alarm relay rating (a.c. & d.c.)	30 V 300 mA
Start-up time	< 3 s
Hold-up time, contact factory	2 - 25 ms
Efficiency ⁴	89 - 93 %
Operating temperature range at 100% load. (Convection cooling) with derating ⁵	-25 to +55 °C -25 to +70 °C
Storage temperature range	-40 to +85 °C

MECHANICAL DRAWING

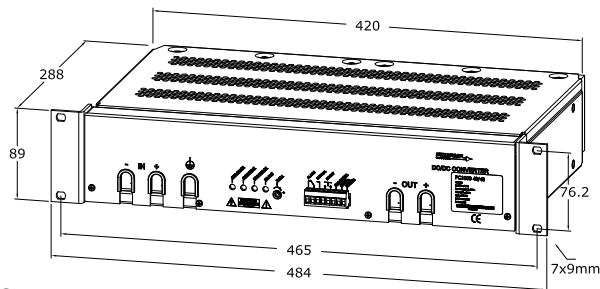
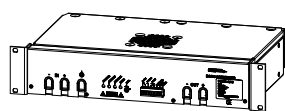
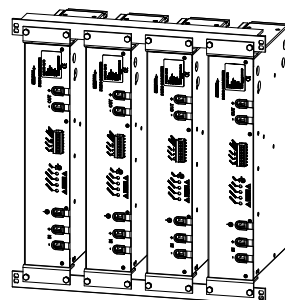

Figure 1. Dimensions

Weight: 8.5 kg



Single unit PC1000/2000 mounted as one 19" unit using standard brackets L89-3



4 units PC1000/2000 mounted vertically, using standard L89-3 brackets and L480-2 (Optional).

PC1000/2000 rackmounted 19" 2U. Using standard brackets L89-3

PC1000/2000 wall mounted. Using mounting brackets L216-1 (Optional)

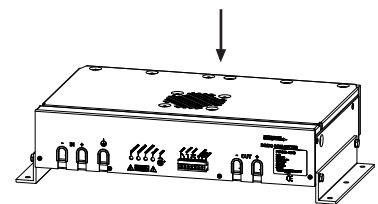

PC1000/2000 wall mounted. Using mounting brackets L100-1 (Optional)

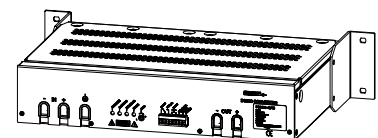

Figure 2. 19"-rack mounting

Figure 3. Wall mounting

CE MARK

PC2000 meets the requirements defined by CE mark as an apparatus.

PC2000 meets requirements of EMC directive and low voltage directive (LVD) and RoHS II directive.

The PC2000 family is in respect to EMC, a stand alone unit can also be installed in any other environment by a professional installer.

Please note that product standards can demand different levels or other basic standard tests. We test according to levels below. For higher levels or other tests, contact factory.

The PC2000 use the safety standard EN IEC 60950-1:2001 for the EMC it meets the requirements of EN IEC 61204-3, EN 50121-2-3:2000, IEC 62236-2-3:2003 and the generic EMC standards.
EN IEC 61000-6-2 (Immunity)
EN IEC 61000-6-3 (Emission)

SAFETY STANDARD EN61204-7

NETWORK	INSTALLATION CLASS	INPUT CODE
Primary circuit	class II (1)	110, 220
Primary circuit	class I (2)	110-220
Secondary circuit	class I (2)	all
SELV circuit	class I (2)	24, 48

1. Pollution degree 2.

2. Pollution degree 3.

ISOLATION TESTABLE LEVELS		TEST VOLTAGE
Input / Output	Input code: 24, 48, 72 Input code: 110, 220	2.5 kVd.c. 3 kVa.c. / 4.3 kVd.c.
Input / Alarm	Input code: 24, 48, 72 Input code: 110, 220	2.5 kVd.c. 3 kVa.c. / 4.3 kVd.c.
Input / Case	Input code: 24, 48, 72 Input code: 110, 220	2.5 kVd.c. 2.5 kVa.c. / 4 kVd.c.
Alarm / Case	Input code: 24, 48, 72 Input code: 110, 220	2 kVd.c. 3 kVa.c. / 4.3 kVd.c.
Alarm / Case		2.5 kVd.c.
Output / Case on <75 Vd.c. output		2.5 kVd.c.
Output / Alarm		2.5 kVd.c.

EMC

EMC STANDARDS	EMC PERFORMANCE		
Emission standards	EN IEC 61000-6-3		Commercial and light-industrial environments
	Input	Output	
EN 55016 CISPR16 (0.15-30 MHz)	OK	OK	opt. EN 55022 level B
EN 55016 CISPR16 (30-1000 MHz)	OK		Enclosure test
Immunity standards	EN IEC 61000-6-2		Industrial environments
EN IEC 61000-4-2	8 kV / 15 kV		Contact / air, Enclosure test
EN IEC 61000-4-3, see note 3	20 V/m AM-Modulated		Output ripple can increase to 0.5% of Vout, Enclosure test
EN IEC 61000-4-4	4 kV	4 kV	
EN IEC 61000-4-5, Input code 24, 48, 72	0.5 kV / 1 kV	0.5 kV / 1 kV	Line-line 2 Ω / Line-case 12 Ω
EN IEC 61000-4-5, Input code 110 ⁴ , 220 ⁴	1 kV / 2 kV	0.5 kV / 1 kV	see note 4
EN IEC 50121-3-2	1 kV / 2 kV	0.5 kV / 1 kV	Line-line 42 Ω / Line-case 42 Ω
EN IEC 61000-4-6	10 V _{RMS}	10 V _{RMS}	AM-Modulated
EN IEC 61000-4-8	30 A/m		Enclosure test
EN IEC 61000-4-10	Not sensitive		Enclosure test

3. 10 V/m do not show any influence.

4. Higher level 2 kV / 4 kV with external filters, contact factory.

We use the EMC product standard "Low voltage power supplies DC output" EN 61204-3 as base for measurement principles. The Immunity EMC levels are elevated in order to comply to EN 50121-3-2 (IEC 62236-3-2) Railway application: Rolling stock – Apparatus, and EN 50121-4 (IEC 62236-4), Railway application: Signaling and telecommunication apparatus. Also to meet relevant parts of IEC 61000-6-5 Generic Standards – Immunity for power stations and substation environments.

SALES OFFICE

Polyamp AB
Box 229
SE-597 25 Åtvidaberg
Sweden
Phone: +46 120 854 10
Telefax: +46 120 854 05
Email: info@polyamp.se
www.polyamp.com



- A secure part of your system

PC1000 / PC1400 / PC2000 Installation manual



Postal address
Box 229
SE-597 25 ÅTVIDABERG
Main residence: Sollentuna

Visit/Shipping
Bäckgatan 10
SE-597 53 ÅTVIDABERG
<https://polyamp.com>

Telephone
+46 120 85400
e-mail: info@polyamp.se

International
+46 120 85405

Doc no-rev 10275-10.doc

Warranty

All Polyamp DC/DC converters are warranted against defective material and workmanship. This warranty is valid for 24 months from the date of delivery. We will repair or replace products which prove to be defective during the warranty period. The warranty is valid only if the converter is used within specification.

Manual

This manual is as complete and actual as possible at the time of printing. However, the information may have been updated since then. Polyamp AB reserves the right to make changes in this manual without notice.



The exclamation point within an equilateral triangle is intended to alert the user to presence of important operating and maintenance instructions in the literature accompanying



The lightning flash with arrowhead, within an equilateral triangle, is intended to alert the user to presence of un-insulated "dangerous voltage" within the products enclosure that may be of sufficient magnitude to constitute a risk of electric shock to persons

Caution!

To prevent the risk of electric shock, do not open enclosure. No serviceable parts inside. Refer servicing to qualified service personnel only

CONTENTS

1 BEFORE INSTALLATION.....	4
2 INSTALLATION.....	5
3 PARALLEL CONNECTION.....	6
3.1 SERIES DIODE ON THE OUTPUT.....	6
3.2 CURRENT SHARING.....	6
3.3 VOLTAGE ADJUSTMENT WITH CURRENT SHARING.....	7
4 MULTIPLE LOADS AT THE OUTPUT.....	8
4.1 SHORT-CIRCUITS.....	8
5 ALARM.....	9
5.1 OVER AND UNDER VOLTAGE ALARM.....	9
5.2 OVER TEMPERATURE.....	9
6 SENSE.....	9
6.1 EXTERNAL SENSE.....	9
7 INHIBIT.....	10
8 OUTPUT OVER VOLTAGE PROTECTION.....	10
9 INRUSH CURRENT LIMIT.....	10
10 ISOLATION VOLTAGE TEST.....	10
10.1 DC ISOLATION TEST OUTPUT TO CASE.....	10
10.2 DC ISOLATION TEST INPUT TO OUTPUT AND INPUT TO CASE.....	11
10.3 AC ISOLATION TEST INPUT TO OUTPUT AND INPUT TO CASE.....	11
11 MAINTENANCE.....	11
12 TROUBLE SHOOTING.....	12
12.1 THERE IS NO OUTPUT VOLTAGE.....	12
12.2 THE INPUT FUSE BLOWS WHEN THE INPUT IS CONNECTED.....	12
12.3 THE CONVERTER STARTS AND STOPS REPEATEDLY.....	12
12.4 THE CONVERTER STOPS AFTER SEVERAL HOURS.....	12
12.5 FAULT REPORT.....	12

1 Before installation

Before installation we recommend that you read this and next section of this manual. If any problem occurs, consult *12 Trouble shooting*.

If the converter includes a fan, please notice *11 Maintenance*.

On the front panel label the following is displayed: Converter type, input voltage range, nominal output voltage, serial number, options and article number. The converter type name consists of model name PC1000, PC1400 or PC2000 followed by input code and output voltage. Two examples:

- **Type: “PC2000 110/48” has input code “110” and nominal output voltage 48Vd.c.**
- **Type: “PC1000 24/24” has input code “24” and nominal output voltage 24Vd.c.**

If you intend to parallel connect the output, please check that option C is supplied. It means series diode on output.

Input, output and case are galvanically separated from each other. You can thus choose how you want the system connected.

The output can be connected with any pole to protective earth or as a floating output with max $\pm 150V$ to the protective earth. It means that maximum 3 units can be put in series.

The electrical safety system is a class I, which means that protective earth has to be connected. The 110 and 220 input code models can also be used as class II equipment without protective earth. Although units installed in dirty environments shall be connected to protective earth.

On 110 and 220 input code the feeding system can be defined as Primary circuit and as Secondary circuit.

On 24 and 48 input code the feeding system can be defined as Secondary circuit voltage, and SELV voltage.

The cables used for input and output feeding shall be dimensioned to fit the fuse rating and continuous current as well as intended ambient temperature range and insulations demand due to the voltage used.

The input is protected against reverse polarity by combination circuit with inrush current

limit circuit. If reverse voltage occurs at installation the converter will not start. The reverse voltage will not cause damage to the unit.

The input shall be fused with an approved fuse with high breaking capacity. We recommend following fuses ratings and fuses. Please note that in installation class I with protective earth, the fuse shall be on the pole not in connection with the protective earth.

PC1000 input fuses

Input voltage code	Time delay fuse
24	63 A, Siemens 3NA3 022
48	35 A, Siemens 3NA3 014
110	16 A, Siemens 3NA3 005
220	10 A, Siemens 3NA3 003

PC1400 input fuses

Input voltage code	Time delay fuse
48	50 A, Siemens 3NA3 020
110	20 A, Siemens 3NA3 007
220	10 A, Siemens 3NA3 003

PC2000 input fuses

Input voltage code	Time delay fuse
48	63 A, Siemens 3NA3 022
110	25 A Siemens 3NA3 010
220	16 A, Siemens 3NA3 005

Table 1. Recommended input fuses.

There are two reasons we do not include the fuse.

1. DC-networks should be fused at the distribution point to protect the cable.
2. Different applications require different types of fuses.

To meet the EMC specifications in the enclosed “declaration of conformity” use twisted-pairs for connecting input, output, alarm, inhibit and voltage sense. Shielded cables are not necessary.

If the converter is mounted in an electric vehicle, an external series diode on the input is recommended. Please contact your Polyamp dealer.

If the converter supplies a DC-motor, we recommend an external parallel diode at the motor poles to protect against reverse voltages.

For the disconnection ability, an external disconnection device, which is able to disconnect both polarities, shall be incorporated with the input power supply cord. The disconnection device must be properly labelled and easy accessible.

2 Installation

The converter is supplied with mounting brackets intended for 19"-rack mounting. The PC1000 converter is convection cooled and in order to get sufficient cooling there shall be a minimum of 30 mm space around the unit except for the sides. PC1000 is only intended for horizontal mounting.

PC1400 and PC2000 use an internal fan and need therefore minimum 30 mm space around the unit except for the sides. The cooling fins at the rear shall never be covered. The fan cooled versions can be mounted in any direction. For mounting plate or chassis mounting please use the L220-1 brackets.

Note that the expected life of the converter is dependent on converter temperature. For every 10°C that the temperature is lowered the expected life is approximately doubled. It is therefore crucial to cater for good ventilation and if possible to reduce ambient temperature.

To meet the EMC specifications in the enclosed "declaration of conformity" use twisted-pairs for connecting input, output, alarm, inhibit and voltage sense. Shielded cables are not necessary.

On 24 and 48 input code the input cables are individual. On 110 and 220 input code use a cable cord with external approved insulation for the Primary circuit and Secondary hazardous voltage rating.

1. Remove front cover with 4 screws and remove the green alarm connector.
On 24 and 48 inputs separate inlets. On 110 and 220 input code put the cable into the cable inlet and fix it with the cable clamp after connection. See *Figure 1. Cable connection for 24V and 48V inputs.* And *Figure 2. Cable connection for 110V and 220V inputs.*
2. First connect protective earth in connector K3 marked with an earth symbol. Then

connect the input IN- to connector K2 and IN+ to connector K1.

3. Connect the output. The converter output is short-circuit proof by a constant current limit which works unlimited in time. Therefore there is no need to fuse the load (unless you use multiple loads or the converter feeds a battery, see below). The current limit is fixed to 105% of nominal output current.
4. If the converter is to be connected in parallel at the output or if you use current sharing for equal current sharing, please consult *3 Parallel connection*.
 - If you intend to use multiple loads, please consult *4 Multiple loads at the output*.
 - If you intend to use the alarm, please consult *5 Alarm*.
 - If you intend to use output voltage sense, please consult *6 Sense*.
 - If you intend to use inhibit, please consult *7 Inhibit*.
5. Mount the front cover and the green alarm connector.
6. Start the converter with your external input disconnection device.
The output voltage can be adjusted +10% to -5% of nominal output voltage with the potentiometer marked V.ADJ on the front panel. Clockwise turn increases the output voltage. The potentiometer has 15 turns. If you are using current sharing, see *3.3 Voltage adjustment with current sharing*.
7. When the converter is to be disconnected, switch-off the input voltage with the disconnecting unit. Disconnect the input cables first, then output and last the protective case connection.



Figure 1. Cable connection for 24V and 48V inputs.

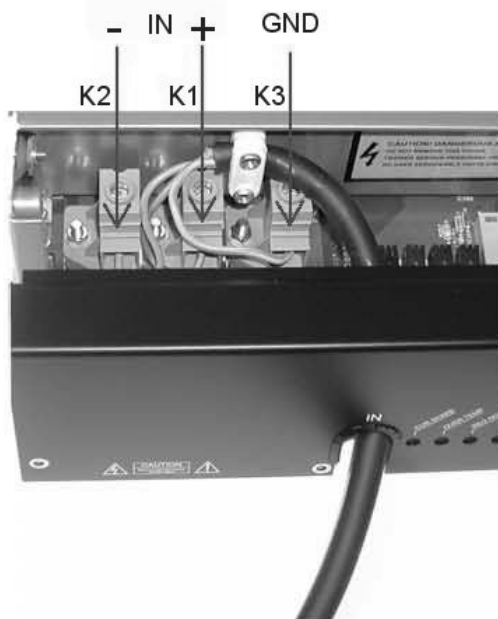

Figure 2. Cable connection for 110V and 220V inputs.

3 Parallel connection

If a redundant power supply system is requested, two or more converters can be connected in parallel. To achieve redundancy the number of converters must be dimensioned to carry the whole load even if one converter is faulty. The unit you will install must be equipped with option C, series diode, please check on the type code label.

You should **not use external sense** when there are several units connected in parallel on the output.

3.1 Series diode on the output

The series diode protects the converter output from external voltage sources. A series diode is necessary if the output is connected in parallel with another power supply or if you require redundant operation. If a converter breaks down with an internal short-circuit on the output and other converters are connected in parallel on the output, the broken unit will short-circuit the others if the series diode is not used. This might cause excessive heat or even fire in the faulty unit.

If the series diode is used, the alarm relay will switch to “ALARM” on the faulty unit if one converter breaks down in a redundant power supply system. Otherwise there will be no alarm indication from a faulty converter unless all units are in current limit and the output voltage drops 10% below nominal output voltage.

On models with option C the output power of the converter is derated. See data sheet.

- On 24Vd.c. output by 10%.
- On 48Vd.c. output by 5%.

Do not forget to fuse the inputs separately to achieve redundancy.

3.2 Current sharing

All models include the automatic current sharing feature, which we recommend to use in parallel configuration. A maximum of 10 units can be connected in parallel.

If more than 10 units should be connected in parallel, contact Polyamp.

Connect a cable (0.25-1.0mm²) with a maximum length of 3.0m between the “CURRENT SHARE” connectors of all units.

The converter with the highest output voltage will then automatically become “current master”. This converter will then run with a few percent higher output current than the others. If the master converter for some reason breaks down, another converter automatically becomes “current master”.

To achieve good power sharing, the voltage drop between the minus poles must be kept as low as possible, see *Figure 3. Current share connection with series diode.* and *Figure 4. Signal connector.* It is important that all cables between the converters and the distribution point has the same length. The plus poles can either be connected as in *Figure 3.* or have separate cables to the load.

The front panel has a yellow LED labeled "CUR SHARE". See *Figure 5. Status panel.* It indicates which converter is currently controlling the output current. At low load (total power output is less than 5%) can the LED "CUR SHARE" jump between the different units. Even at different loads or load changes can "CUR SHARE" LED switching device. This is normal.

Parallel output connection of several converters powered by two input voltage sources. See *Fel! Hittar inte referenskälla..*

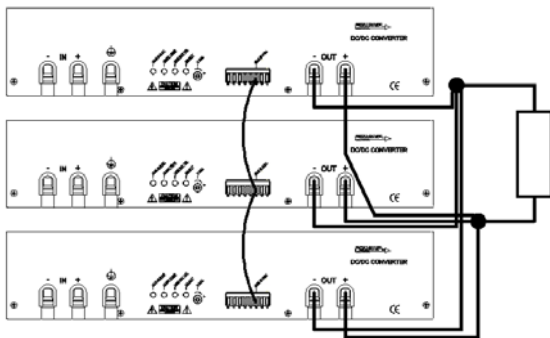

Figure 3. Current share connection with series diode.

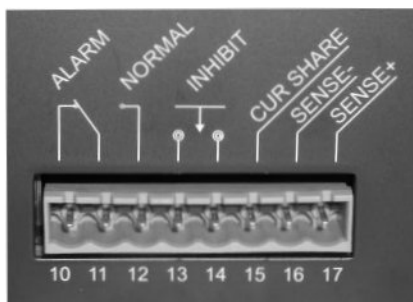

Figure 4. Signal connector

3.3 Voltage adjustment with current sharing

The converters must be running with 5% of nom. load or more, and the "current share" must be connected. If each converter output

voltage is adjusted to the same voltage, which they are at delivery, the yellow "CUR. SHARE" LED might be lit on most units.

To **increase** the output voltage:

1. Choose a unit where the "CUR. SHARE" LED is lit. Turn the V.ADJ potentiometer clockwise until you reach your desired output voltage.
2. The other units should now also be adjusted to approximately the same output voltage, otherwise the output voltage will drop if the master converter breaks down. Turn the V.ADJ potentiometer slowly clockwise on the other units until the "CUR. SHARE" LED is lit or almost lit.

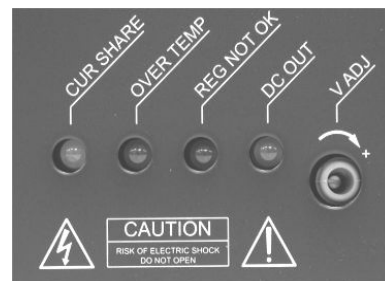

Figure 5. Status panel

To **decrease** the output voltage:

1. Turn the V.ADJ potentiometer approximately one (1) turn counter clockwise on all converters but one. This will not affect the output voltage yet.
2. Turn the V.ADJ potentiometer counter clockwise on the remaining converter (if your load current exceeds 5% of the total rated current, this should be the only unit with the "CUR. SHARE" LED lit) until you reach the output voltage you desire. (If you turn more than one (1) turn counter clockwise you must repeat from step 1).
3. The other units should now also be adjusted to approximately the same output voltage. Otherwise the output voltage will drop if the master converter breaks down. Turn clockwise on the V.ADJ potentiometer on the other units slowly until the "CUR. SHARE" LED is lit or almost lit.

4 Multiple loads at the output

If you are using several loads, we recommend fusing them separately with fast acting fuses on the positive output branch. See *Figure 6. Connecting multiple loads.*

4.1 Short-circuits

1. If there is a short-circuit in one branch and the total current in all branches **does not** exceed 105% of the nominal current of the converter (see label on front panel), the output voltage will not be affected. The time for the fuse to blow can be calculated from the data sheet of the fuse if you know the short-circuit current through the fuse.
2. If there is a short-circuit in one branch and the total current in all branches **does** exceed 105% of the nominal current of the converter, the output voltage will drop until the fuse is blown. Depending on the impedance of the short-circuit (whether it is abrupt or merely an overload) and the resistance of the load cables, the effects of a short-circuit will vary.

Long cables reduce short-circuit currents, resulting in longer delay until the fuse is blown and hence an increased voltage dip. Light overload does not necessarily result in a blown fuse.

To reduce the voltage drop at short-circuit and if any branch has more than approximately 30% of the total output current of the converter, a large external capacitor is recommended. Such a capacitor will supply the peak current needed to blow the fuse, see *Figure 6*. To calculate the capacitor needed, use the following formula:

$$C = 1.2 \times (I_S \times \Delta t) / \Delta U$$

1.2 = Safety margin.

I_S = Short-circuit current through the fuse.

Δt = Time before the fuse blows (see data sheet on the fuse).

ΔU = Acceptable voltage dip before the fuse blows.

Example: You have a 5A fuse with fast characteristic and the short-circuit current is 50A. The data sheet gives you that $\Delta t = 10\text{ms}$. The output voltage is 24V, and you can accept 10% voltage drop $\Rightarrow \Delta U = 24 \times 0.1 = 2.4\text{V}$.

The capacitance you need:

$$C = 1.2 \times (I_S \times \Delta t) / \Delta U = 1.2 \times 50 \times 0.01 / 2.4 = 250,000\mu\text{F}$$

Choose a capacitance with a rated voltage of at least 115% of nominal output voltage of the converter.

Repeat this calculation for all branches and choose the highest capacitance value.

3. It is sometimes difficult to estimate the short-circuit current when the nature of a fault is unknown. In this case a voltage dip might appear under some short-circuit conditions even with a large capacitor present. If a voltage dip is critical in one branch it is recommended to use a separate DC/DC converter supplying this branch.

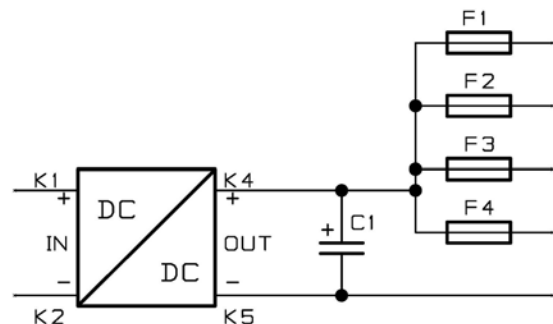

Figure 6. Connecting multiple loads.

5 Alarm

The alarm relay switches to “ALARM” state if:

- The output voltage is not within +15% /- 10% of nominal output voltage.
- The converter is overheated.

Otherwise the relay contact is in the position “NORMAL”.

See *Figure 4. Signal connector*.

The alarm relay can be connected in two ways:

1. Open in “NORMAL” position.
 - Connect twisted-pair (0.25mm² - 1.5mm²) from centre pin (11) of the removable alarm connector and connector pin (10) marked “ALARM”.
2. Closed in “NORMAL” position.
 - Connect twisted-pair (0.25mm² - 1.5mm²) from centre pin (11) of the removable alarm connector and connector pin (12) marked “NORMAL”.

The relay is isolated from input, output and case, see the data sheet. The relay can switch maximum 30V/300mA (a.c. and d.c. values).

5.1 Over and under voltage alarm

The alarm relay switches to alarm and the “REG NOT OK” LED, (see *Figure 5. Status panel*) is lit when the output voltage is approximately 15% higher or 10% lower than nominal output voltage.

5.2 Over temperature

All models have thermal protection. If the converter is overheated it shut down the output current. The “OVER TEMP” LED (see *Figure 5. Status panel*) is lit and the alarm relay is set to alarm. This will not occur in normal operation with an ambient temperature below +55°C when the unit has sufficient cooling. The converter type PC1000 is convection cooled and there should be a minimum of 30-50mm of free space at upper and lower parts of

the converter. If this is not possible, we recommend the use of an external fan.

Note that the expected life of the converter is dependent on converter temperature. For every 10°C that the temperature is decreased the expected life is approximately doubled. It is therefore crucial to cater for good ventilation and if possible reduce ambient temperature.

6 Sense

6.1 External sense

External sense is used when voltage regulation at the load is critical. The converter regulates the voltage at the load and not at the output of the converter and does thereby compensate for voltage drop in the cables between the converter and the load. The maximum voltage compensation is 5% of nominal output voltage.

Warning!

Do not connect or disconnect any cables when converter is switched on if the sense cables are used. This might damage the converter and it is also **not advisable for your own protection to make adjustments in the installation with voltage applied.**

Installation

1. The converter must be switched off
2. Connect a twisted-pair (0.25mm² - 1.5mm²) between the “SENSE +” (17) and “SENSE -” (16) (see *Figure 4. Signal connector*) of the converter and the load. The sense leads and the power cables shall be of approximately the same length and drawn as close to each other as possible. **Beware of correct polarity!** “SENSE +” to plus at the load and “SENSE -” to minus. See *Figure 7 External sense*.

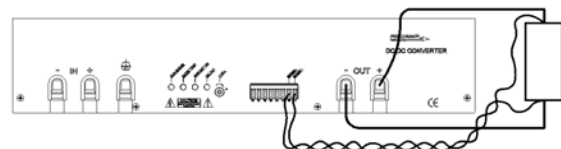

Figure 7. External sense.

7 Inhibit

The converter is shut-down if the inhibit input 13 and 14 (see *Figure 4. Signal connector.*) is short-circuited by a relay or an electrical switch. The current through the short-circuit is 20mA. Note that there is no electrical isolation between the “inhibit” and the output.

Use a twisted-pair (0.25mm² - 1.5mm²) with a maximum length of 3.0m for connection of the “inhibit”.

8 Output over voltage protection

All models are equipped with an internal output over voltage protection circuit (OVP). It consists of an additional voltage regulator operating in parallel with the main regulator. The output voltage is limited to approximately 15% above the nominal output voltage. As long as the OVP circuit is active the alarm relay is set to “ALARM” state and the red “REG NOT OK” LED (see *Figure 5 Status panel*) is lit.

9 Inrush current limit

All models are equipped with an inrush current limit feature. The input capacitors are charged through a resistor to reduce the input current during start up. When the converter starts this resistor is shunted by power relay.

All models have a “slow start” feature. To reduce input current during start up the output capacitors are charged “slowly” (approximately 0.1s).

10 Isolation voltage test

Each converter has been isolation tested in factory before deliveries see *Table 2.*

Warning 1. An isolation test shall only be performed by personnel aware of the dangers and hazards of the test.

Warning 2. Consecutive insulation test will damage the Y-capacitors provoking less EMC performance.

Input code	Isolation In/out, In/case	Output voltage Vd.c.	Isolation out/case
24, 48, 72,	2.5kVd.c.	24, 48	2.5kVd.c.
110, 220,	3kVa.c./ 4.3Vd.c.	24, 48	2.5kVd.c.

Table 2. Isolation voltages on different converters.

10.1 DC isolation test output to case

1. Disconnect all cables from the converter.
2. Connect the input terminals of the converter to case.
3. Connect the output terminals together. Connect your isolation tester between output and case. See *Figure 8. Output to case isolation voltage test.*
4. Raise the voltage of the isolation tester from 0 to actual test voltage (see *Table 2. Isolation voltages on different converters..* Check that the leakage current does not exceed 5µA. The voltage should not be applied for more than a few seconds or the Y-capacitors might be damaged.
5. Turn off the isolation tester and discharge the test voltage with a 10 MΩ resistor between output and case.

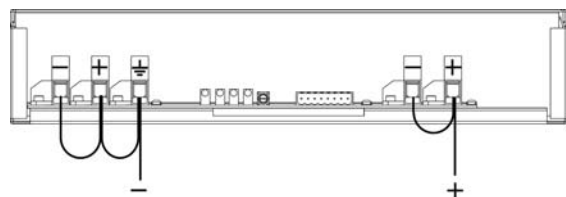

Figure 8. Output to case isolation voltage test.

10.2 DC isolation test input to output and input to case

1. Disconnect all cables from the converter.
2. Connect the output terminals of the converter to case.
3. Connect the input terminals together.
4. Connect your isolation tester between input and case. See *Figure 9. Input to output and input to case isolation voltage test.* Raise the voltage of the isolation tester from 0 to actual test voltage (see *Table 2*). Check that the leakage current does not exceed $5\mu\text{A}$. The voltage should not be applied for more than a few seconds or the Y-capacitors might be damaged.
5. Turn off the isolation tester and discharge the test voltage with a $10\text{ M}\Omega$ resistor between input and case.

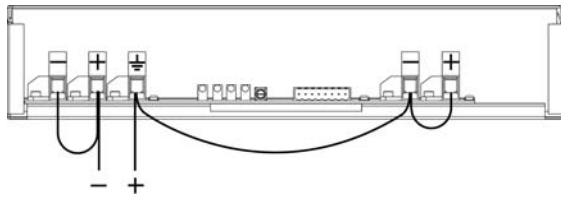

Figure 9. Input to output and input to case isolation voltage test.

10.3 AC isolation test input to output and input to case

Beware of the rather high capacitive earth currents (about 100mA) that will occur during this test.

If your isolation test equipment cannot supply this current, you can perform a DC isolation test. Follow the instructions in *10.2 DC isolation test input to output and input to case.*

AC isolation test:

1. Disconnect all cables from the converter.
2. Connect the output terminals of the converter to case.
3. Connect the input terminals together see *Figure 9. Input to output and input to case isolation voltage test.*

4. Connect your isolation tester between input and case. See *Figure 9. Input to output and input to case isolation voltage test.* Raise the voltage of the isolation tester from 0 to actual test voltage, see *Table 2*. The voltage should not be applied for more than a few seconds or the Y-capacitors might be damaged.
5. Turn off the isolation tester and discharge the test voltage with a $10\text{ M}\Omega$ resistor between input and case.

11 Maintenance

A converter that includes a fan has to be subject to maintenance. The fan needs to be replaced by a new one every 5 year. Instruction how to replace it, see *Figure 10. Replacing the fan.*

The fan has article. no. 203330 and can be ordered from Polyamp AB, address see 12.5.

12 Trouble shooting

12.1 There is no output voltage

1. Check that the input fuse is not broken.
2. Check that the input voltage polarity is correct.
3. Check that the input voltage is within the specified limits, see front label.
4. If only the red "REG NOT OK" LED is lit, the converter may be in current limit due to excessive output current or an external short-circuit on the output.
 - Disconnect the input.
 - Disconnect the load.
 - Connect the input again and measure the output voltage.
If the converter now starts the load was too heavy or there was a short-circuit.
 - If there is an external short-circuit, remove it.
 - If the load is too large decrease the load or consult your Polyamp dealer.
5. Check that the "INHIBIT" input is not short-circuited. See 7 *Inhibit*.
6. Check that the "SENSE" is connected correctly. See 6 *Sense*.
7. The unit is broken. Contact your Polyamp dealer.

12.2 The input fuse blows when the input is connected

1. Check that the input voltage polarity is correct.
2. Check that the input fuse is of time delay type and with correct current rating. See *Table 1*.
3. The unit is broken. Contact your Polyamp dealer.

12.3 The converter starts and stops repeatedly

All models have an over/under voltage protection on input which shuts down the converter if the input voltage is not within specified limits (see front label).

1. The cables to the converter input may be under-sized, causing too high voltage drop in the supply cables.
2. Check that there is not excessive voltage drop in the external input disconnecting device or in the input fuse holder due to bad contact.
3. Your supply does not have enough current capacity so the input voltage to the converter drops below specified limit.

12.4 The converter stops after several hours

If the red "OVER TEMP" LED is lit, the unit has not sufficient cooling or the ambient temperature is too high.

- See 5.2 *Over temperature* for further information.
- If the converter includes a fan. Check that it is working. If not, replace it. See 11 *Maintenance*.

12.5 Fault report

We suggest that you return a faulty converter to:

POLYAMP AB
Bäckgatan 10
SE 597 53 ÅTVIDABERG
SWEDEN

Telephone: +46 120 85 400
email: info@polyamp.se
<https://polyamp.com>

Or to your local Polyamp distributor.

To help us locate the fault, please describe the fault and how and when it occurred.

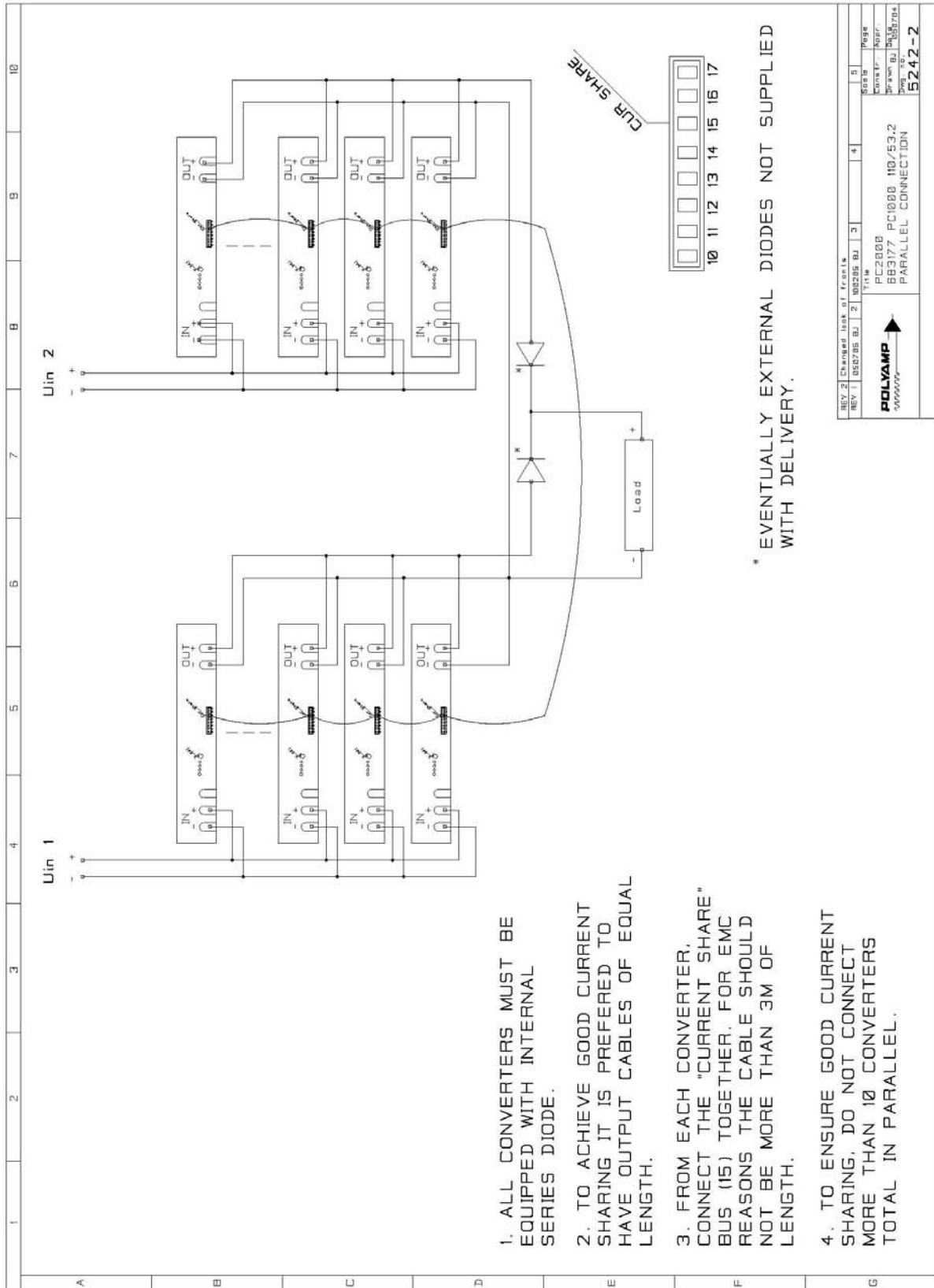

Figure 11. Two supply systems with common load and parallel converter outputs.

CE Declaration of Conformity

Hereby Polyamp declares that our DC/DC converter type:

PC1000 models		PC1400 & PC2000 models	
PC1000 24/24	PC1000 48/24	PC1400 48/24	
PC1000 24/28	PC1000 48/28	PC1400 48/28	
PC1000 24/36	PC1000 48/36	PC1400 48/36	
PC1000 24/48	PC1000 48/48	PC1400 48/48	PC2000 48/48
PC1000 24/53.2			PC2000 48/53.2

conforms to:

EMC directive 2014/30/EU, Low voltage directive 2014/35/EU and 2011/65/EU RoHS directive.

EN 50581:2012 Technical documentation for RoHS.

This unit is conforming to the product safety standard and product EMC standard:

EN 61204-3:2018 Low-voltage switch mode power supplies. Part 3 Electromagnetic compatibility (EMC), See performance levels in below table.

EN 61204-7:2018 Low-voltage switch mode power supplies - Part 7: Safety requirements

EMC performance	Input	Enclosure	Output
Emission requirement EN61000-6-3:2007			
EN 55016-2-1:2017 (Conducted 0.15 to 30 MHz)	OK		OK
EN 55016-2-1:2017 (Radiated 30 to 1000 MHz)	Included	OK	Included
Immunity requirement EN61000-6-2:2017 with elevated levels			
EN61000-4-2:2009 Contact / Air discharge	8kV	8kV	8kV
EN61000-4-3:2010 80 to 1000 MHz; 1 kHz, 80% AM-modulated carrier	Included	10 V/m	Included
1.4 to 2.0 GHz 1 kHz, 80% AM-modulated carrier	Included	10 V/m	Included
2.0 to 2.7 GHz 1 kHz, 80% AM-modulated carrier	Included	10 V/m	Included
EN61000-4-4:2012 Burst	±4 kV		±4 kV
EN61000-4-5:2017:			
line-line 2 Ω	±1 kV		±0.5 kV
line-line 12 Ω	±2 kV		±1 kV
line-line 42 Ω			±1 kV
line-case 12 Ω	±2 kV		±2 kV
line-case 42 Ω			±2 kV
EN61000-4-6:2015 (Conducted 0.15 to 80 MHz), 80% AM-modulated carrier	10 VRMS		10 VRMS
EN61000-4-8:2010	Not sensitive	Not sensitive	Not sensitive



Eric Östlund,
Managing Director

POLYAMP AB

MAILING ADDRESS
BOX 229
SE-597 25 ÄTVIDABERG
SWEDEN
MAIN RESIDENCE: SOLLENTUNA

VISIT/SHIPPING
BÄCKGATAN 10
597 53 ÄTVIDABERG
SWEDEN
VAT.no: SE556103276301

TEL. INTL.
+46 120 85400

E-MAIL
info@polyamp.se
https://polyamp.com
CAGE/NCAGE: S4231/A163N
DUNS: 35-430-3372

CE Declaration of Conformity

Hereby Polyamp declares that our DC/DC converter type:

PC1000 models		PC1400 & PC2000 models	
ف PC1000 110/24	ف PC1000 220/24	ف PC1400 110/24	ف PC1400 220/24
ف PC1000 110/28	ف PC1000 220/28	ف PC1400 110/28	ف PC1400 220/28
ف PC1000 110/36	ف PC1000 220/36	ف PC1400 110/36	ف PC2000 220/36
ف PC1000 110/48	ف PC1000 220/48	ف PC1400 110/48	ف PC2000 220/48
ف PC1000 110/53.2			ف PC2000 220/53.2

conforms to:

EMC directive 2014/30/EU, Low voltage directive 2014/35/EU and 2011/65/EU RoHS directive.

EN 50581:2012 Technical documentation for RoHS.

This unit is conforming to the product safety standard and product EMC standard:

EN 61204-3:2018 Low-voltage switch mode power supplies. Part 3 Electromagnetic compatibility (EMC), See performance levels in below table.

EN 61204-7:2018 Low-voltage switch mode power supplies - Part 7: Safety requirements

EMC performance	Input	Enclosure	Output
Emission requirement EN61000-6-3:2007			
EN 55016-2-1:2017 (Conducted 0.15 to 30 MHz)	OK		OK
EN 55016-2-1:2017 (Radiated 30 to 1000 MHz)	Included	OK	Included
Immunity requirement EN61000-6-2:2017 with elevated levels			
EN61000-4-2:2009 Contact / Air discharge	8kV	8kV	8kV
EN61000-4-3:2010 80 to 1000 MHz; 1 kHz, 80% AM-modulated carrier	Included	10 V/m	Included
1.4 to 2.0 GHz 1 kHz, 80% AM-modulated carrier	Included	10 V/m	Included
2.0 to 2.7 GHz 1 kHz, 80% AM-modulated carrier	Included	10 V/m	Included
EN61000-4-4:2012 Burst	±4 kV		±4 kV
EN61000-4-5:2017:			
line-line 2 Ω	±1 kV		±0.5 kV
line-line 12 Ω	±2 kV		±1 kV
line-line 42 Ω			±1 kV
line-case 12 Ω	±2 kV		±2 kV
line-case 42 Ω			±2 kV
EN61000-4-6:2015 (Conducted 0.15 to 80 MHz), 80% AM-modulated carrier	10 VRMS		10 VRMS
EN61000-4-8:2010	Not sensitive	Not sensitive	Not sensitive



Eric Östlund,
Managing Director

POLYAMP AB

MAILING ADDRESS
BOX 229
SE-597 25 ÄTVIDABERG
SWEDEN
MAIN RESIDENCE: SOLLENTUNA

VISIT/SHIPPING
BÄCKGATAN 10
597 53 ÄTVIDABERG
SWEDEN
VAT.no: SE556103276301

TEL. INTL.
+46 120 85400

E-MAIL
info@polyamp.se
https://polyamp.com
CAGE/NCAGE: S4231/A163N
DUNS: 35-430-3372

PC1000 / PC1400 / PC2000 Mechanical drawings



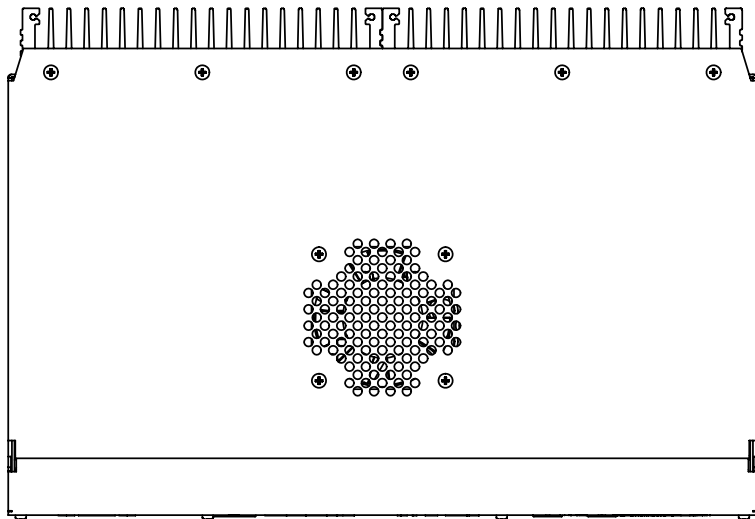
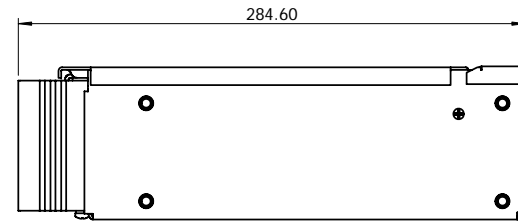
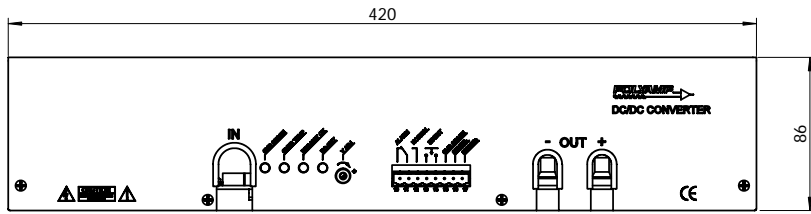

This document is the property of Polyamp AB and shall not, without the permission of Polyamp AB, be allowed, copied, used for manufacturing or communicated to any other person or company.

Weight (kg/m3)	Replaces dwg	Page 1(1)	Associated dwg No.	Units millimeters	Scale 1:3	Rev No 00
		PC1000 / PC2000			Tolerances/Tolerances ISO 2768-1	Designer roand Date (y/m/d) 041004
					Approved by m	Date (y/m/d)
					RA 6,3	Rev by
					Dwg No.	PC1000

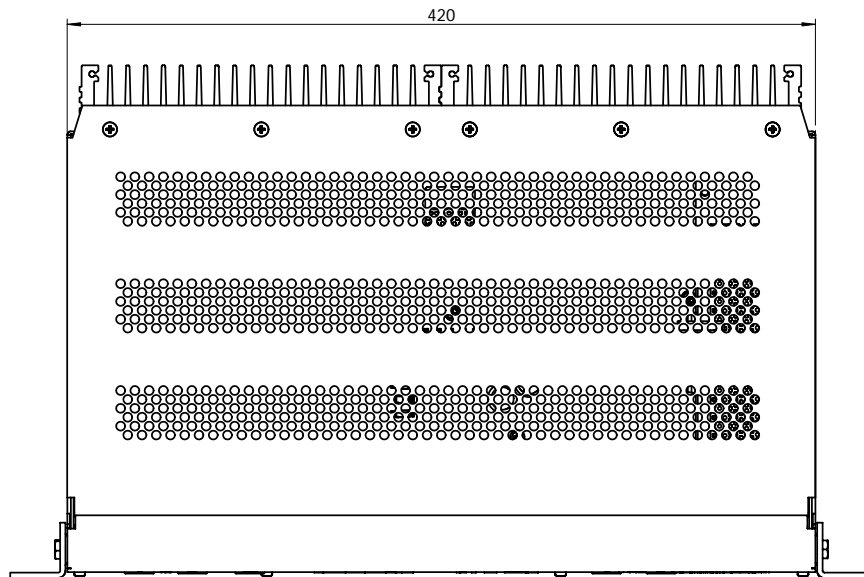
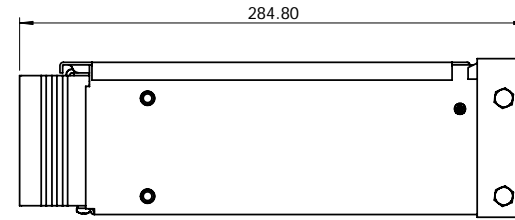
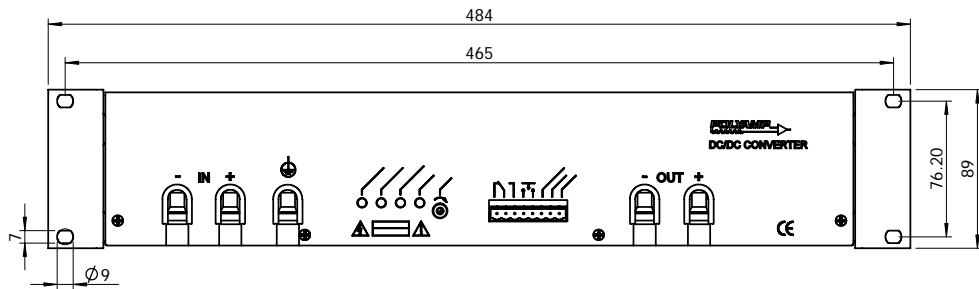

This document is the property of Polyamp AB and shall not, without the permission of Polyamp AB be allowed, copied, used for manufacturing or communicated to any other person or company.

Weight (kg/ft3)	Replaces dwg	Page 1(1)	Associated dwg No.	Units millimeters	Scale 1:3	Rev No. 00
		PC1000 / PC2000 L89-3 Standard mounting		Tolerances/Tolerances IS:ISO 2768-1		Designer roand Date (y/m/d) 041004
				Approved by m Date (y/m/d) -		Rev by RA 6,3 Date (y/m/d) -
Dwg No. -				4802-00		

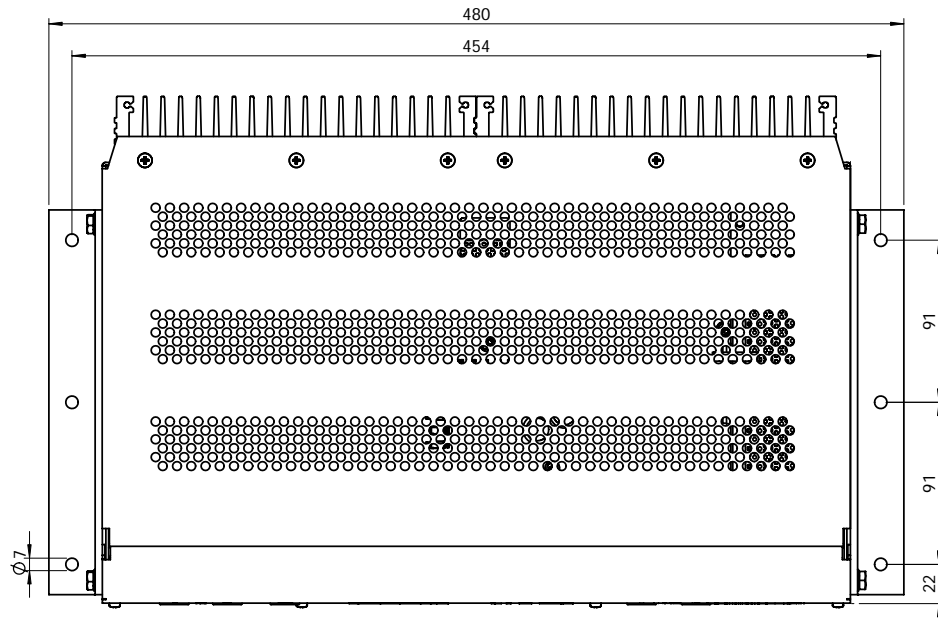
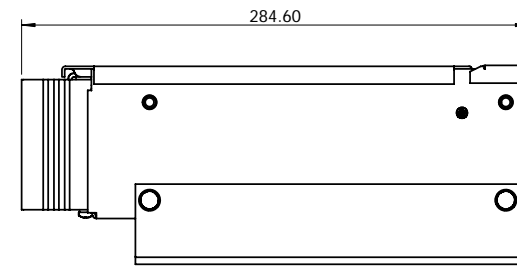
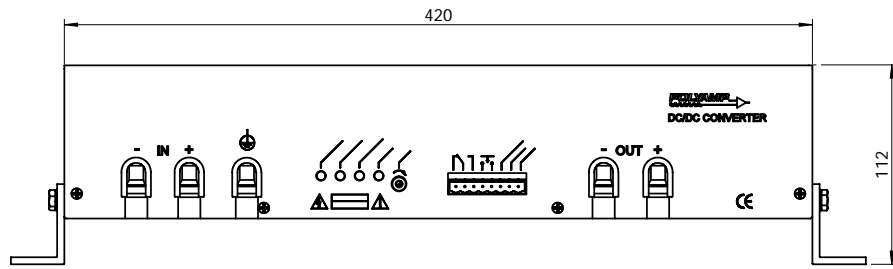

This document is the property of Polyamp AB and shall not, without the permission of Polyamp AB be allowed, copied, used for manufacturing or communicated to any other person or company.

Weight (kg/m3)	Replaces dwg	Page 1(1)	Associated dwg No	Units millimeters	Scale 1:3	Rev No 00
	PC1000 / PC2000		Tolerances/Tolerances RS/ISO 2768-1	Designer roand	Date (y/m/d) 041004	
	400080		m	Approved by	Date (y/m/d)	
	L216-1		Njammhet/Surf. test	RA 6,3	Rev by	Date (y/m/d)
	Wall mounting		Dwg No	4805-00		

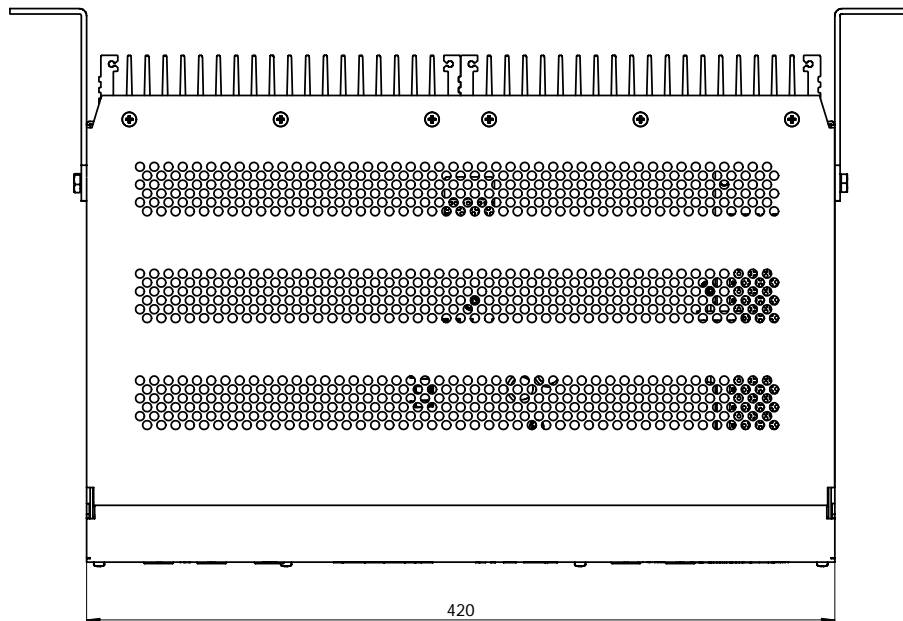
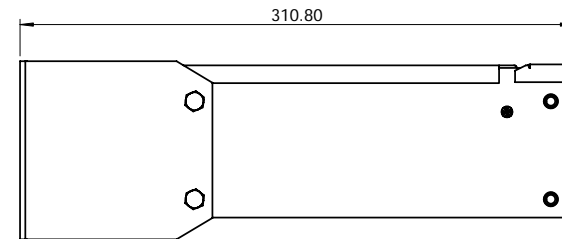
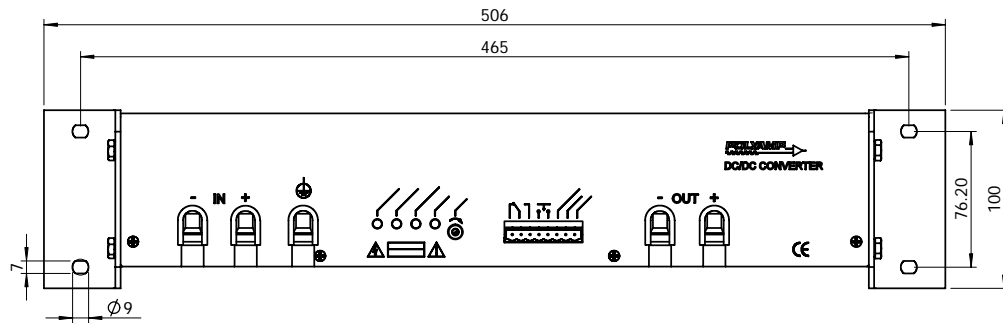

This document is the property of Polyamp. All and shall not, without the permission of Polyamp. All be allowed, copied, used for manufacturing or communicated to any other person or company.

Weight (kg/m ³)	Replaces (dwg)	Page 1(1)	Associated dwg No.	Units millimeters	Scale 1:3	Rev No. 00
		PC1000 / PC2000 400082 L100-1 Wall mounting		Tolerances/Tolerances IS:ISO 2768-1 m Njammhet/Surf. list RA 6,3	Designer roand Approved by Rev by	Date (y/m/d) 041004 Date (y/m/d) Date (y/m/d)
Dwg No.					4803-00	

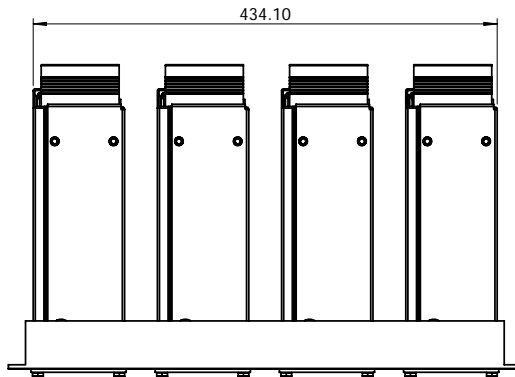
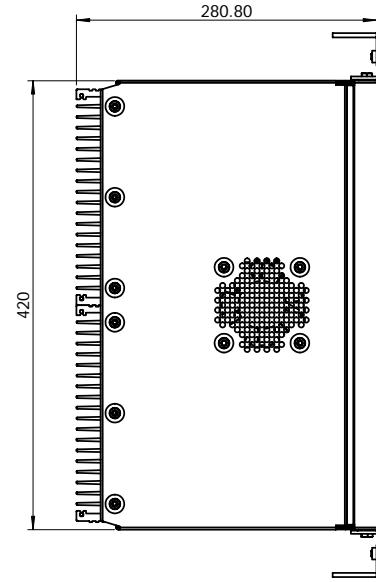
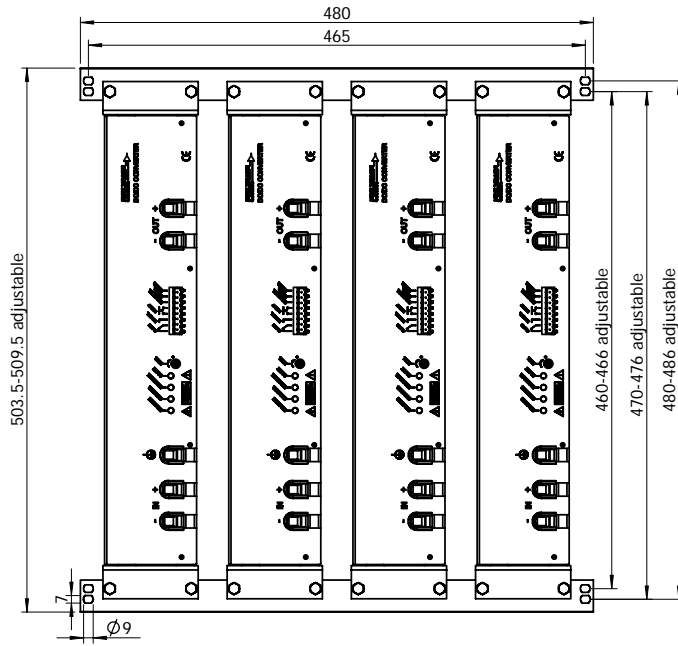

This type of mounting require fan-model

Weight (kg/m)	Replaces dwg	Page 1(1)	Associated dwg No.	Units millimeters	Scale 1:5	Rev No 00
	PC1400 / PC2000 fan-model		Designer roand	Date (y/m/d) 090113	Tolerance/Tolerances RS40 2/6.1	
	400084		Approved by	Date (y/m/d)	m	
	L480-2 / L89-3		Rev by	Date (y/m/d)	RA 6,3	
19" 4 units		Dwg No.		5864-00		

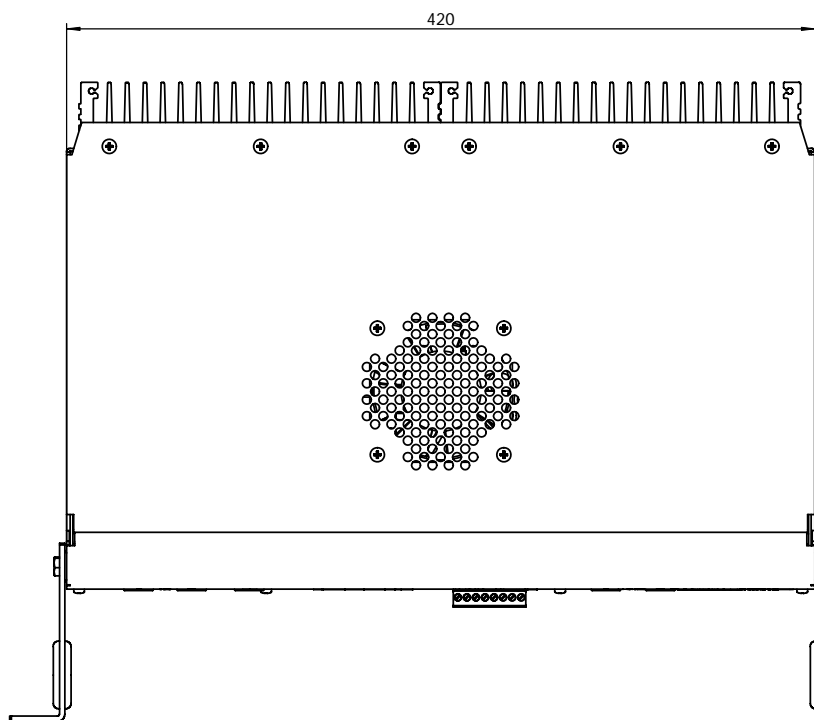
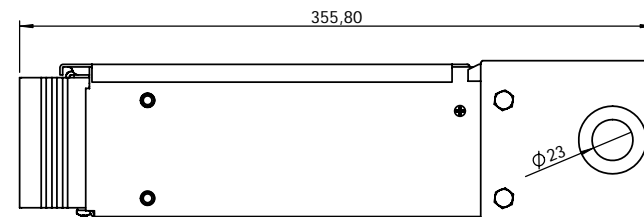
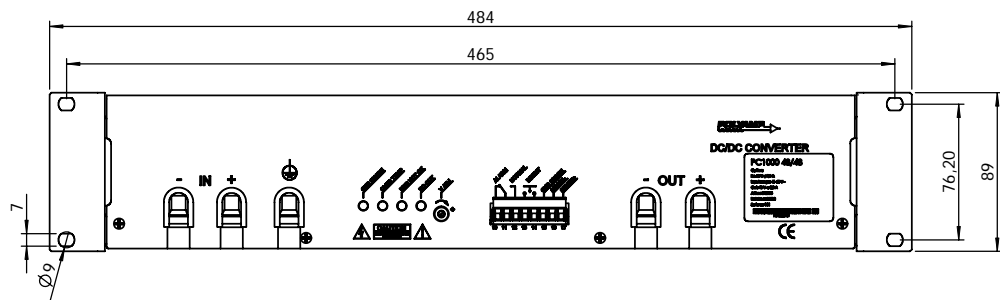

This document is the property of Polyamp AB and shall not, without the permission of Polyamp AB, be allowed, copied, used for manufacturing or communicated to any other person or company.

Weight (kg/m3)	Replaces (dwg)	Page 1(1)	Associated dwg No.	Units millimeters	Scale 1:3	Rev No 00
	PC1000 / PC2000		Tolerances/Tolerances 0.1/0.2/0.3		Designer roand	Date 120627
	400083		m		Approved by	Date
	L89-4		RA 6,3		Rev by	Date
	Rack mounting		Dwg No.		7194-00	



SALES OFFICE

Polyamp AB
Box 229
SE-597 25 Åtvidaberg
Sweden
Phone: +46 120 854 10

Email: info@polyamp.se
<https://polyamp.com>

HEAD OFFICE

Polyamp AB
Hovslagarevägen 31
SE-192 54 Sollentuna
Sweden
Phone: +46 8 594 693 00

